

ENGLISH

User manual



Table of contents

| | | |
|--------|--|----|
| 1 | PRECAUTIONS AND SAFETY MEASURES | 2 |
| 1.1 | Preliminary instructions | 2 |
| 1.2 | During use..... | 3 |
| 1.3 | After use..... | 3 |
| 1.4 | Definition of measurement (overvoltage) category | 3 |
| 2 | GENERAL DESCRIPTION | 4 |
| 2.1 | Instrument features | 4 |
| 3 | PREPARATION FOR USE | 4 |
| 3.1 | Initial inspections..... | 4 |
| 3.2 | Power supply | 4 |
| 3.3 | Calibration..... | 4 |
| 3.4 | Storage | 4 |
| 4 | OPERATING INSTRUCTIONS..... | 5 |
| 4.1 | Instrument description..... | 5 |
| 4.2 | Description of function keys | 5 |
| 4.3 | Description of display..... | 6 |
| 4.4 | Description of measuring leads..... | 7 |
| 4.5 | GUARD lead | 7 |
| 4.6 | Notes on the insulation measurements..... | 7 |
| 4.7 | Switch on the instrument..... | 8 |
| 4.2.1. | Auto Power OFF | 8 |
| 4.8 | Insulation measurement in FIX mode | 9 |
| 4.8.1 | Configuration of the test parameters for FIX mode..... | 12 |
| 4.9 | Insulation measurement in ADJUST mode..... | 13 |
| 4.9.1 | Configuration of the test parameters for ADJUST mode | 16 |
| 4.10 | Insulation measurement in RAMP mode | 17 |
| 4.10.1 | Configuration of the test parameters for RAMP#1 mode..... | 21 |
| 4.10.2 | Configuration of the test parameters for RAMP#2 mode..... | 21 |
| 4.10.3 | Configuration of the test parameters for RAMP#3 mode..... | 22 |
| 4.11 | Enable/Disable of SMOOTH function | 22 |
| 4.12 | Anomalous situations..... | 22 |
| 5 | MANAGEMENT OF MEMORY DATA | 25 |
| 5.1 | Save measurements | 25 |
| 5.2 | Delete measurements..... | 25 |
| 5.3 | Recall measurements | 26 |
| 6 | RESET OF INSTRUMENT | 26 |
| 7 | CONNECTION OF THE INSTRUMENT TO PC | 26 |
| 8 | MAINTENANCE | 27 |
| 8.1 | General information | 27 |
| 8.2 | Recharging internal battery..... | 27 |
| 8.3 | Cleaning the instrument..... | 27 |
| 8.4 | End of life..... | 27 |
| 9 | TECHNICAL SPECIFICATIONS | 28 |
| 9.1 | Reference guidelines | 29 |
| 9.2 | General characteristics | 29 |
| 9.3 | Environment..... | 30 |
| 9.4.1. | Environmental conditions for use..... | 30 |
| 9.4 | Accessories..... | 30 |
| 10 | SERVICE..... | 31 |
| 10.1 | Warranty conditions | 31 |
| 10.2 | Service | 31 |
| 11 | THEORETICAL APPENDIX | 32 |
| 11.1 | Polarization Index (PI)..... | 32 |
| 11.2 | Dielectric Absorption Ratio (DAR)..... | 32 |

1 PRECAUTIONS AND SAFETY MEASURES

The instrument has been designed in compliance with standards IEC/EN61557 and IEC/EN61010-1 regarding electronic measuring instruments.

CAUTION



For the operator's safety and to prevent damaging the instrument, follow the procedures described in this manual and carefully read all notes preceded by the symbol .

Before and during measurements, carefully observe the following instructions:

- Do not perform any measurement in humid environments, in the presence of gas or explosive or inflammable material or in dusty areas
- Even when no measurements are being performed, avoid any contact with the circuit being tested, with exposed metal parts, with unused measuring leads or circuits, etc
- Do not perform any measurement when anomalies are found in the instrument, such as deformations, breaks, substance leaks, no display view, etc
- Pay special attention when measuring voltages above 25V in special environments (building yards, swimming pools, etc.) and 50V in ordinary environments, as there is the danger of electric shocks.

In this manual and on the instrument, the following symbols are used:



CAUTION: it is necessary to consult the instruction manual to find the type of potential danger and the actions to be taken.

Observe the instructions reported in the manual. An improper use could damage the instrument and lead to dangerous situations for the operator.



DC voltage or current.



AC voltage or current.



Dangerous voltages: risk of electric shocks.



Instrument with double insulation.

1.1 PRELIMINARY INSTRUCTIONS

- This instrument has been designed for use in an environment with pollution level 2
- It may also be used to test industrial electrical systems up to overvoltage category IV 600V to earth with maximum voltage 600V between inputs
- Follow the usual safety rules to protect the operator from dangerous currents and protect the instrument against improper use
- Never use the instrument resting on the floor, it must be placed over flat horizontal surfaces
- Only the accessories supplied with the instrument guarantee safety standards. They must be in good conditions and replaced, if necessary, with identical models
- Do not measure systems exceeding the current and voltage limit values specified
- Do not perform measurements in environmental conditions not within the limit values indicated in this manual
- Before connecting the probes to the circuit to be tested, check that the correct function is selected.

1.2 DURING USE

Carefully read the following recommendations and instructions:



CAUTION

Failure to observe the cautions and/or instructions may damage the instrument and/or its components or generate a danger for the operator. If, during use, the low battery symbol appears on the display, insert the supply cable into the Europlug socket to start battery recharge. During battery recharge, it is possible to perform measurements.

- Before selecting a new function, disconnect the measuring probes from the circuit
- When the instrument is connected to the circuit being tested, never touch any unused lead
- Avoid measuring resistance with external voltages; even if the instrument is protected, as an excess voltage may cause instrument malfunctions
- Prevent that the instrument receives voltage during measurement (e.g. a probe slipping from the measuring point and touching a point under voltage)
- Avoid inserting the plug of the supply cable into the Europlug socket while measuring.

1.3 AFTER USE

When measurements are completed, turn off the instrument by pressing the ON/OFF key.

1.4 DEFINITION OF MEASUREMENT (OVERVOLTAGE) CATEGORY

Standard "IEC/EN61010-1: Safety requirements for electrical equipment for measurement, control and laboratory use, Part 1: General requirements", defines what is intended for measurement category, commonly known as overvoltage category. In § 6.7.4: Measuring circuits, it reads:

Circuits are divided into the following measurement categories:

- **Measurement category IV** is for measurements performed at the source of a low-voltage installation
Examples are electric counters and measurements on primary devices protecting against overcurrents and on ripple adjusting units
- **Measurement category III** is for measurements performed on installations inside buildings
Examples are measurements performed on distribution boards, circuit breakers, wiring harnesses, including cables, bars, junction boxes, switches, sockets of fixed installations and appliances designed for industrial use and other equipment, e.g. stationary motors connected to fixed systems.
- **Measurement category II** is for measurements performed on circuits directly connected to the low-voltage installation.
Examples are measurements performed on household appliances, portable tools and similar equipment.
- **Measurement category I** is for measurements performed on circuits not directly connected to the MAINS.
Examples are measurements performed on circuits not derived from the MAINS and on circuits derived from the MAINS provided with a special (internal) protection. In this latter case, the stress caused by the transients is variable; therefore, (OMISSIS) it is necessary that the user knows the appliance's resistance to transients.

2 GENERAL DESCRIPTION

The instrument You purchased, if used in compliance with the indications given in this manual, guarantees accurate and reliable measurements and the utmost safety thanks to a development of new conception which ensures double insulation and, consequently, compliance with the requirements of overvoltage category IV.

2.1 INSTRUMENT FEATURES

- Insulation resistance measurement with nominal voltage which can be set up to 5kV
- Dielectric leakage current measurement
- Polarization Index (PI) measurement
- Dielectric Absorption Ratio (DAR) measurement
- Capacitance measurement.
- AC/DC voltage measurement up to 600V

3 PREPARATION FOR USE

3.1 INITIAL INSPECTIONS

Before shipment, the instrument's electronics and mechanics have been inspected. All possible precautions have been taken in order for the instrument to be delivered without damage.

However, we recommend generally inspecting the instrument in order to detect any damage suffered during transport. Should you detect any anomalies, immediately contact the forwarding agent or the dealer.

Moreover, we recommend checking that the package contains all parts listed in § 9.4. Should you find any discrepancy, please contact the dealer. Should it become necessary to return the instrument, please follow the instructions reported in § 10

3.2 POWER SUPPLY

The instrument is power-supplied through internal batteries which are recharged from the mains by means of a battery charger integrated in the instrument itself. The symbol "" steadily illuminated in the right bottom part indicates that the batteries are flat and must be recharged. To recharge the batteries, follow the instructions given in § 8.2

3.3 CALIBRATION

The instrument complies with the technical specifications reported in this manual. Its correct operation is guaranteed for one year from the date of purchase.

3.4 STORAGE

In order to guarantee accurate measurements and protect the instrument from possible failures, after a long storage period under extreme environmental conditions, wait for the instrument to return to a normal condition (see § 9.4.1).

4 OPERATING INSTRUCTIONS

4.1 INSTRUMENT DESCRIPTION

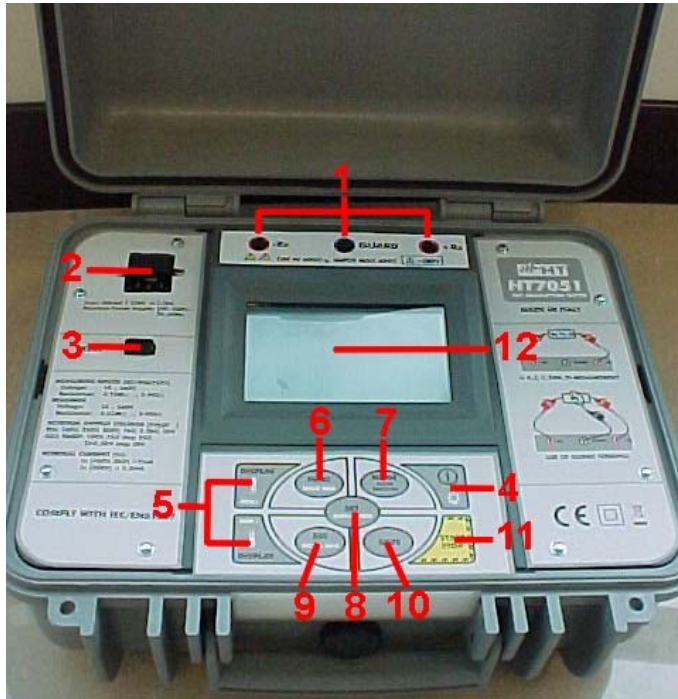

CAPTION:

1. Input bushings
2. Europlug socket
3. RS232 connector
4. **ON/OFF** key
5. Multifunction arrow keys
6. **FUNC/ERASE MEM** key
7. **MODE/CLEAR SMOOTH** key
8. **SET/DISPLAY MEM** key
9. **ESC/RECALL MEM** key
10. **SAVE** key
11. **START/STOP** key
12. LCD display

Fig. 1: Instrument description

4.2 DESCRIPTION OF FUNCTION KEYS

| Key | Description |
|-----|---|
| | Multifunction arrow keys → they have several functions which are described in detail below |
| | ON/OFF key → used for: <ul style="list-style-type: none"> • Switch on/off the instrument • Switch on the display's backlighting for 20 seconds (short pressing of the key with the instrument already on) |
| | FUNC/ERASE MEM key → used for: <ul style="list-style-type: none"> • Select the desired function • Delete the measurements saved during the display of memory data |
| | MODE/CLEAR SMOOTH key → used for: <ul style="list-style-type: none"> • Change the internal modes (if there are more available modes) • The pressure of the key set the default value of the selected parameter |
| | SET/DISPLAY MEM key → used for: <ul style="list-style-type: none"> • Set the test parameters of a function • The pressure of the key shows the dates of the measurement saved inside the memory |



| | |
|---|--|
|  | <p>ESC/RECALL MEM key → used for:</p> <ul style="list-style-type: none"> • Access to the data saved in the memory (if present) • From a parameter setting screen or memory data display screen, pressing the key once allows returning to the previous screen |
|  | <p>SAVE key → used for:</p> <ul style="list-style-type: none"> • Once a measurement has been completed, pressing the key once allows saving the results in the memory • From a parameter setting screen, pressing the key once allows saving the changes made to the parameters |
|  | <p>START/STOP key → used for:</p> <ul style="list-style-type: none"> • Start and/or stop a measurement |

Table 1: Description of function keys

4.3 DESCRIPTION OF DISPLAY









| Symbol | Description |
|---|--|
|  | <p>Display group 1 shows:</p> <ul style="list-style-type: none"> • Insulation resistance • Dielectric leakage current • PI (Polarization Index) • DAR (Dielectric Absorption Ratio) • Capacitance |
|  | <p>Display group 2 shows:</p> <ul style="list-style-type: none"> • Nominal test voltage • Generated test voltage |
|  | <p>Display group 3 shows the duration time of the test</p> |
|  | <p>Bargraph</p> |
|  | <p>Modes available test : FIX, ADJUST and RAMP</p> |
|  | <p>“Flash”, Alarm (values over limits), “Warning” symbols</p> |
|  | <p>“Low battery”, “Mains supply”, “Timer” symbols</p> |
|  | <p>“Number of test cycles” symbol</p> |

Table 2: Description of symbols of display

4.4 DESCRIPTION OF MEASURING LEADS

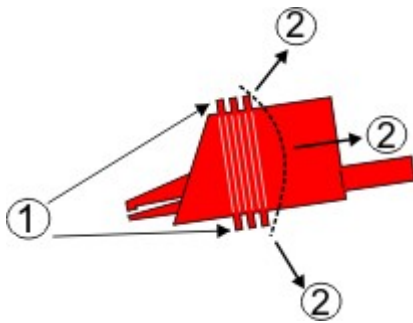

CAPTION:

1. Hand protection
2. Safety areas

Fig. 2: Measuring leads

4.5 GUARD LEAD

In some cases, measurements could be affected by surface currents. By applying voltage to an insulation to be measured, there may be two distinct currents: one flowing in the test piece, the other flowing on its surface. In case you want to measure only the resistance due to current I_m flowing in the test piece R_x (which is the significant one), it is necessary to absorb the surface current I_f using another lead.

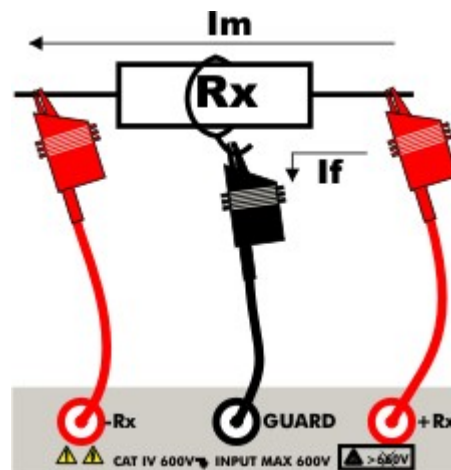

Fig. 3: Currents flowing in the test piece

4.6 NOTES ON THE INSULATION MEASUREMENTS

Measuring a high resistance such as the insulation resistance is very difficult as the value of the currents considered may be very low. When measuring, to prevent making mistakes, it is therefore necessary to take the following precautions:



CAUTION

- Keep the measuring leads suspended above the path or, anyway, make sure the leads do not make contact in more of one point
- While measuring high resistances, the area around the measuring instrument and the appliance being tested must be free. It is recommended to use the timer function so that the operator may keep at due distance from the leads and from the resistance to be tested
- It is recommended to use the GUARD lead to measure resistances of some tens of $G\Omega$ or higher
- **While use the instrument with main supply, it's important to check that the earthed resistance pole to measure is connected to the instrument R_x+ Terminal**

4.7 SWITCH ON THE INSTRUMENT

After switch on, the instrument gives a short acoustic signal and, for approximately one second, all segments of the display appear.

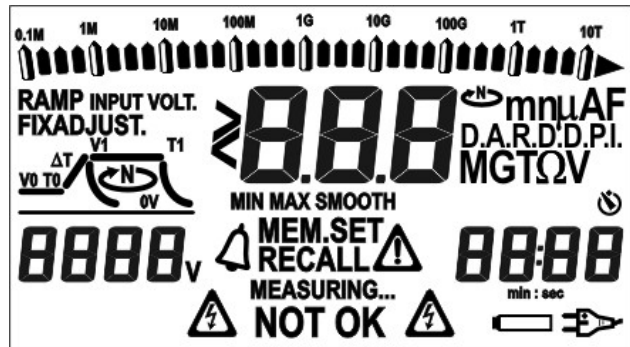

Then, the instrument shows the firmware version, then it sets to the last measuring mode selected before turning off.



4.2.1. Auto Power OFF

If no test is being carried out, the instrument automatically turns off after approximately 5 minutes after the last time a key was pressed. To reactivate the instrument, it is necessary to turn it on again by pressing the relevant key.

4.8 INSULATION MEASUREMENT IN FIX MODE

This measurement mode, performed in compliance with IEC/ EN61557-2 guideline, allows a quick selection of the test voltage among the values: 250, 500, 1000, 2500, and 5000VDC.



CAUTION

- The instrument may be used on installations of overvoltage category CAT IV 600V to earth with maximum voltage 600V between inputs. Do not connect the instrument to installations with voltages exceeding the limit values indicated in this manual. If these limit values are exceeded, the operator may be exposed to electrical shocks and the instrument could get damaged
- Always connect the measuring leads to the instrument and to the alligator clips with the accessories disconnected from the system
- It is recommended to hold the alligator clip respecting the safety area marked by the hand protection (see § 4.4)

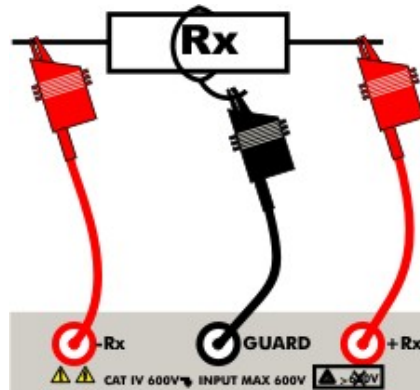
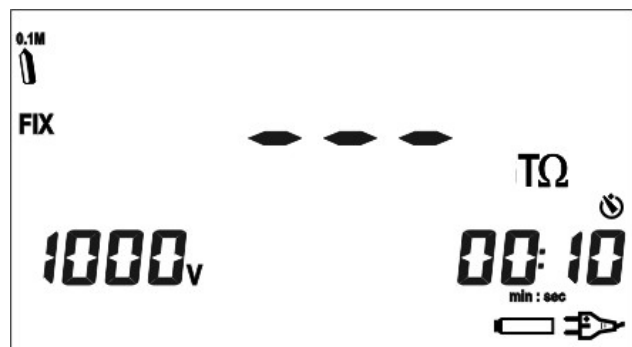

Fig. 4: Instrument connection

1. Turn on the instrument by press **ON/OFF**/ key
2. Press the **FUNC/ERASE MEM** key to select the "FIX" mode
3. The display shows a screen similar to that reported here to the side, which contains:

- The FIX selected mode
- The bargraph set to zero
- The "--- TΩ" indication
- The selected test voltage
- The test time value
- The plug symbol (if the instrument is supplied from the mains)
- The battery symbol steadily illuminated or flashing (if batteries are flat or are being recharged)
- The TIMER symbol if the duration of the test has been set



4. By pressing the arrow keys, the instrument shows a screen similar to that reported here to the side, which contains the value of the input voltage.



5. Press the **MODE/CLEAR SMOOTH** key to set one of the following test voltages: 250V, 500V, 1000V, 2500V, 5000V
6. Insert the measuring leads into the relevant input leads of the instrument -Rx, +Rx and GUARD, if necessary (see § 4.5 and Fig. 4)

CAUTION



Make sure that there is no voltage at the ends of the measuring points before connecting them to the measuring leads.

7. Connect the alligator clips to the part of the system to be tested
8. Press the **START/STOP** key to perform measurement

CAUTION



The display shows the message "**Measuring...**" which indicates that the instrument is performing the measurement. During this whole phase:

- Do not disconnect the measuring leads of the instrument from the conductor being tested; the conductor could remain live at a dangerous voltage because of possible stray capacitances in the circuit tested;
- Never insert the plug of the supply cable into the Europlug socket.

9. During measurement, the instrument gives a short acoustic signal every second and the display shows a screen similar to that reported here to the side, which contains:

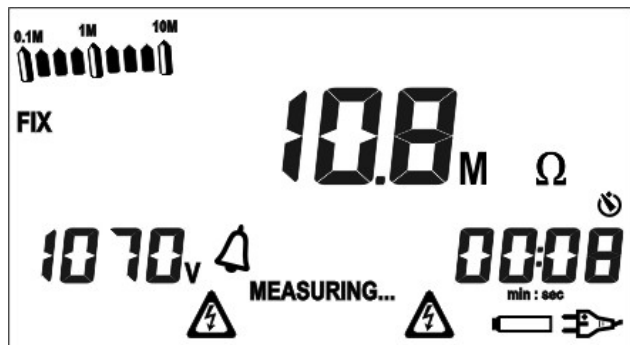

- The FIX selected mode
- The bargraph proportional to the measured resistance value
- The numerical indication of the measured resistance
- The applied test voltage
- The symbol of the alarm bell (if the measured value is not within the set limits and/or if the value of the test voltage is lower than the set nominal value)
- The value of the test time elapsed or remaining (if a test has been set)
- The plug symbol (if the instrument is supplied from the mains)
- The battery symbol steadily illuminated or flashing (if batteries are flat or are being recharged)
- The timer symbol if the duration of the test has been preset
- The two "flash" symbols to indicate a dangerous voltage
- The message "**MEASURING...**"

While measuring, it is also possible to display the leakage current, the DAR (Dielectric Absorption Ratio if test duration > 1 minute), the PI (Polarization Index if test duration > 10 minutes) which cyclically show when pressing the arrow keys (see § 11.1)

10. If no measuring time was set when setting the parameters or if you want to stop the test in advance before the set time elapses, press the **START/STOP** key

11a. Once measurement is complete and any capacitance has been discharged, the instrument shows:

- The value of the measured insulation resistance;
- The value of the generated voltage;
- The duration of the test
- If the measured resistance value is between the (MIN - MAX) limits previously set, the instrument shows OK and gives a double acoustic signal (see § 4.10.1)

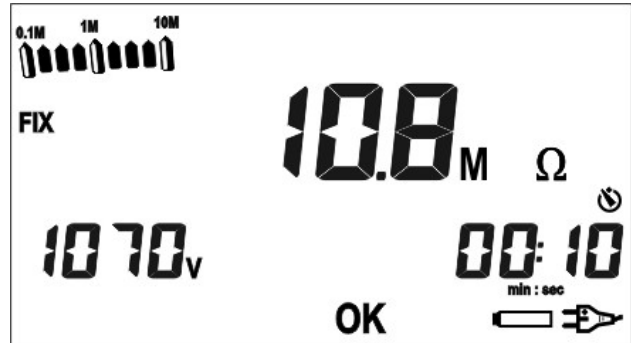

OR

11b. Once measurement is complete and any capacitance has been discharged, the instrument shows:

- The value of the measured insulation resistance
- The value of the generated voltage
- The duration of the test
- If the measured resistance value is not between the (MIN - MAX) limits previously set, the instrument shows NOT OK, the alarm bell and gives a long acoustic signal (see § 4.10.1)



12. Once measurement is complete, it is also possible to display the leakage current, the DAR (Dielectric Absorption Ratio), the PI (Polarization Index) and the capacitance which cyclically show when pressing the arrow keys (see § 11.1)



CAUTION

- If the measured resistance value <math>< 5.0\text{M}\Omega</math>, the screen displaying the capacitance shows three hyphens “---”, to indicate that it was impossible to measure the capacitance, and the symbol
- If, when scrolling the results obtained, the capacitance value is > 1nF, it is recommended to repeat the measurement by activating the SMOOTH function (see § 4.11)

13. Measures can be saved by pressing the **SAVE** key twice (see § 5.1)

4.8.1 Configuration of the test parameters for FIX mode

- a. By cyclically pressing the **SET/DISPLAY MEM** key, it is possible to select the following parameters:
 - Minimum value of the insulation (MIN) in a range between 0,01M Ω - MAX
 - Maximum value of the insulation (MAX) in a range between (MIN) - 10T Ω
 - Test time value in a range between (00min:05sec) - (99min:59 sec)
- b. Press the arrow keys to change the value of the parameters (a long pressing of the keys allows a rapid change of the values)
- c. Press the **MODE/CLEAR SMOOTH** key to remove the limit values set for the parameters. The display shows the message "no" to indicate that there is no limit set.
- d. After setting, press the **SAVE** key to save the changes made or press the **ESC/RECALL MEM** key to exit without saving and return to the previous screen

4.9 INSULATION MEASUREMENT IN ADJUST MODE

This function is performed in compliance with IEC/ EN61557-2 guideline. The ADJUST mode allows the fine adjustment of the test voltage between 100 - 5000VDC.

CAUTION



- The instrument may be used on installations of overvoltage category CAT IV 600V to earth with maximum voltage 600V between inputs. Do not connect the instrument to installations with voltages exceeding the limit values indicated in this manual. If these limit values are exceeded, the operator may be exposed to electrical shocks and the instrument could get damaged
- Always connect the measuring leads to the instrument and to the alligator clips with the accessories disconnected from the system
- We recommend holding the alligator clip respecting the safety area marked by the hand protection (see § 4.4)

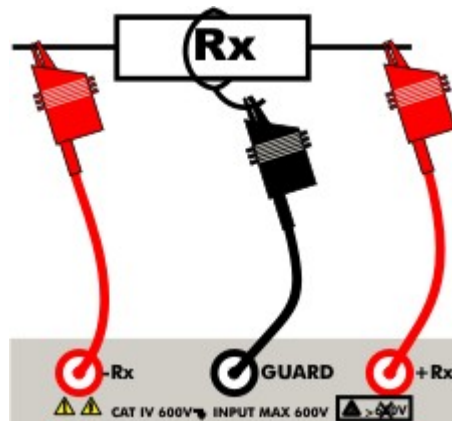
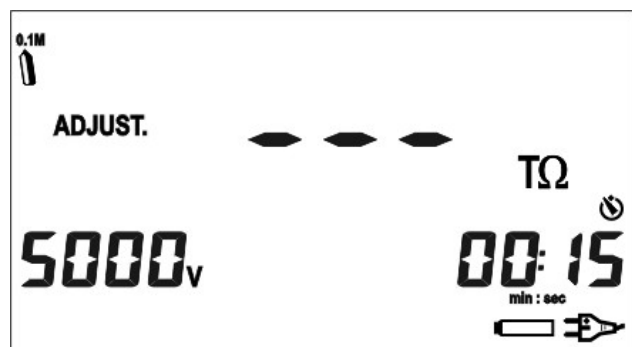

Fig. 5: Instrument connection

1. Turn on the instrument by pressing the relevant key
2. Press the **FUNC/ERASE MEM** key to select the "ADJUST" mode
3. The display shows a screen similar to that reported here to the side, which contains:

- The ADJUST function selected
- The bar graph set to zero
- The indication "--- TΩ"
- The test voltage
- The value of the test time
- The plug symbol (if the instrument is supplied from the mains)
- The battery symbol steadily illuminated or flashing (if batteries are flat or are being recharged)
- The timer symbol if the duration of the test has been preset



4. By pressing the arrow keys, the instrument shows a screen similar to that reported here to the side, which contains the value of the input voltage.



5. Make sure that the set test voltage is the desired one. Should it not be the case, please refer to § 4.9.1 to change it
6. Insert the measuring leads into the relevant input leads of the instrument -Rx, +Rx and GUARD, if necessary (see § 4.5 and Fig. 5)

CAUTION



Make sure that there is no voltage at the ends of the measuring points before connecting them to the measuring leads.

7. Connect the alligator clips to the part of the system to be tested.
8. Press the START/STOP key to perform measurement

CAUTION



The display shows the message “Measuring...” which indicates that the instrument is performing the measurement. During this whole phase:

- Do not disconnect the measuring leads of the instrument from the conductor being tested; the conductor could remain live at a dangerous voltage because of possible stray capacitances in the circuit tested
- Never insert the plug of the supply cable into the Europlug socket.

9. During measurement, the instrument gives a short acoustic signal every second and the display shows a screen similar to that reported here to the side, which contains:

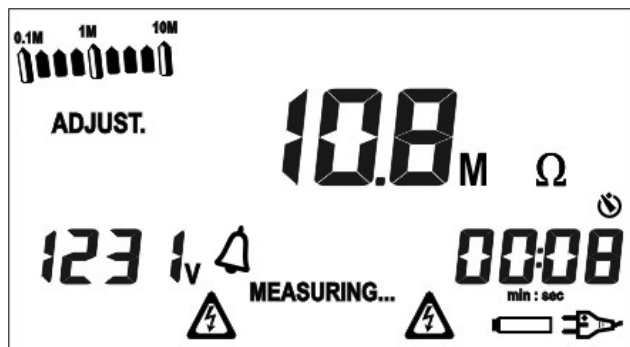

- The ADJUST function selected
- The bar graph proportional to the measured resistance value
- The numerical indication of the measured resistance
- The actual test voltage
- The symbol of the alarm bell (if the measured value is not within the set limits and/or if the value of the test voltage is lower than the set nominal value)
- The value of the test time elapsed or remaining (if a test has been set)
- The plug symbol (if the instrument is supplied from the mains)
- The battery symbol steadily illuminated or flashing (if batteries are flat or are being recharged)
- The timer symbol if the duration of the test has been preset
- The two “flash” symbols to indicate a dangerous voltage
- The message “MEASURING...”

While measuring, it is also possible to display the leakage current, the DAR (Dielectric Absorption Ratio if test duration > 1 minute), the PI (Polarization Index if test duration > 10 minutes) which cyclically show when pressing the arrow keys (see §11.1)

10. If no measuring time was set when setting the parameters or if you want to stop the test in advance before the set time elapses, press the **START/STOP** key
- 11a. Once measurement is complete and any capacitance has been discharged, the instrument shows:
- The value of the measured insulation resistance
 - The value of the generated voltage
 - The duration of the test
 - If the measured resistance value is between the (MIN - MAX) limits previously set, the instrument shows OK and gives a double acoustic signal (see § 4.9.1)

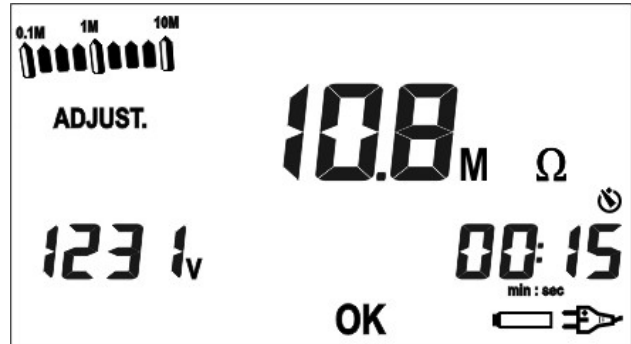

OR

- 11b. Once measurement is complete and any capacitance has been discharged, the instrument shows:
- The value of the measured insulation resistance
 - The value of the generated voltage
 - The duration of the test
 - If the measured resistance value is not between the (MIN - MAX) limits previously set, the instrument shows NOT OK, the alarm bell and gives a long acoustic signal (see § 4.9.1)



12. Once measurement is complete, it is also possible to display the leakage current, the DAR (Dielectric Absorption Ratio), the PI (Polarization Index) and the capacitance which cyclically show when pressing the arrow keys (see § 11.1)

CAUTION



- If the measured resistance value <math>< 5,0M\Omega</math>, the screen displaying the capacitance shows three hyphens “---“, to indicate that it was impossible to measure the capacitance, and the symbol
- If, when scrolling the results obtained, the capacitance value is > 1nF, it is recommended to repeat the measurement by activating the SMOOTH function (see § 4.11)

13. Measures can be saved by pressing the **SAVE** key twice (see § 5.1)

4.9.1 Configuration of the test parameters for ADJUST mode

- a. By cyclically pressing the SET/DISPLAY MEM key, it is possible to select the following parameters:
 - Minimum value of the insulation (MIN) in a range between 0,01M Ω - MAX
 - Maximum value of the insulation (MAX) in a range between (MIN) - 10T Ω
 - Value of the test voltage in a range between 100V - 5000V (can be set in steps of 25V up to 1000V and in steps of 50V from 1000V to 5000V)
 - Test time value in a range between (00min:05sec) - (99min:59 sec).
- b. Press the arrow keys to change the value of the parameters (a long pressing of the keys allows a rapid change of the values).
- c. Press the **MODE/CLEAR SMOOTH** key to remove the limit values set for the parameters. The display shows the message "no" to indicate that there is no limit set. Only when setting the value of the test voltage, by pressing the **MODE/CLEAR SMOOTH** key, the voltage sets to the default value of 1000V.
- d. After setting, press the **SAVE** key to save the changes made or press the **ESC/RECALL MEM** key to exit without saving and return to the previous screen

4.10 INSULATION MEASUREMENT IN RAMP MODE

This function is performed in compliance with standard IEC/ EN61557-2. The RAMP mode allows choosing among three different types of ramps:



For each type of ramp, it is possible to set the duration, the test voltage and the number of times the ramp is repeated (§ 4.10.1, § 4.10.2, § 4.10.3).

- RAMP#1:** Voltage starts from 0V, reaches the value V1 in a time interval ΔT , keeps the value V1 for a time T1, and finally returns to 0 (with possible discharge of the residual voltage).
- RAMP#2:** Voltage starts from 0V, which is kept for a time T0, reaches the value V1 in a time interval ΔT , and finally returns to 0 (with possible discharge of the residual voltage).
- RAMP#3:** Voltage starts from 0V, which is kept for a time T0, reaches the value V1 in a time interval ΔT , keeps to value V1 for a time T1, and finally returns to 0 (with possible discharge of the residual voltage).

CAUTION



- The instrument may be used on installations of overvoltage category CAT IV 600V to earth with maximum voltage 600V between inputs. Do not connect the instrument to installations with voltages exceeding the limit values indicated in this manual. If these limit values are exceeded, the operator may be exposed to electrical shocks and the instrument could get damaged
- Always connect the measuring leads to the instrument and to the alligator clips with the accessories disconnected from the system
- It is recommended to hold the alligator clip respecting the safety area marked by the hand protection (see § 4.4)

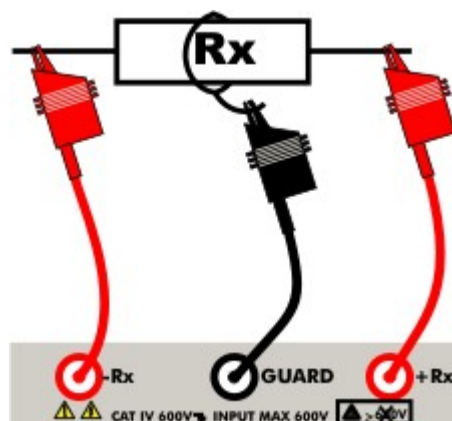
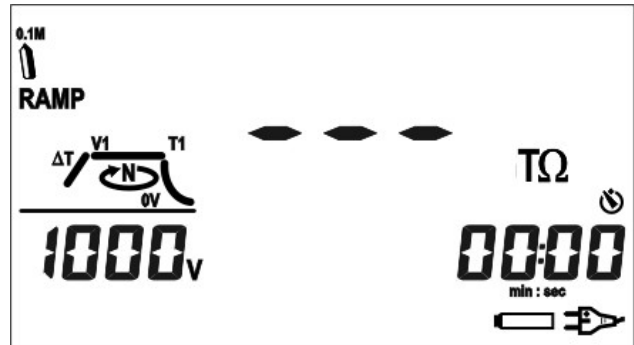

Fig. 6: Instrument connection

1. Turn on the instrument by press the **ON/OFF** key
2. Press the **FUNC** key to select the RAMP function.

3. The display shows a screen similar to that reported here to the side, which contains:

- The RAMP type selected
- The bar graph set to zero
- The indication "--- TΩ"
- The set test voltage
- The value of the test time
- The plug symbol (if the instrument is supplied from the mains)
- The battery symbol steadily illuminated or flashing (if batteries are flat or are being recharged)
- The timer symbol if the duration of the test has been preset.



4. By pressing the arrow keys, the instrument shows a screen similar to that reported here to the side, which contains the value of the input voltage.



5. Insert the measuring leads into the relevant input leads of the instrument -Rx, +Rx and GUARD, if necessary (see § 4.5 and Fig. 6)

CAUTION



Make sure that there is no voltage at the ends of the measuring points before connecting them to the measuring leads.

6. Connect the alligator clips to the part of the system to be tested.
7. Press the **START/STOP** key to perform measurement.

CAUTION



The display shows the message "**Measuring...**" which indicates that the instrument is performing the measurement. During this whole phase:

- Do not disconnect the measuring leads of the instrument from the conductor being tested; the conductor could remain live at a dangerous voltage because of possible stray capacitances in the circuit tested
- Never insert the plug of the supply cable into the Europlug socket

8. During measurement, the instrument gives a short acoustic signal every second and the display shows a screen similar to that reported here to the side, which contains:

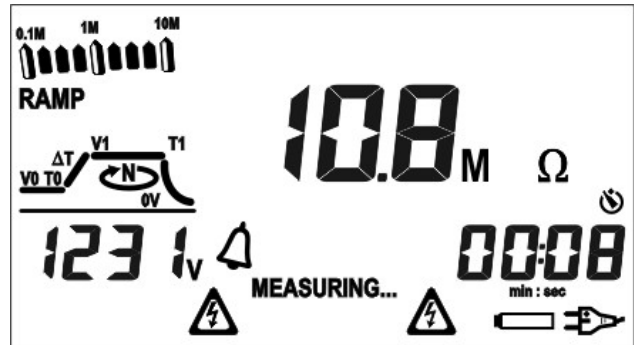

- The RAMP function selected
- The bar graph proportional to the measured resistance value
- The numerical indication of the measured resistance
- The segment relevant to the current ramp point, flashing
- The actual test voltage (relevant to the current ramp point)
- The symbol of the alarm bell (if the measured value is not within the set limits and/or if the value of the test voltage is lower than the set nominal value)
- The value of the remaining test time (relevant to the current ramp point)
- The plug symbol (if the instrument is supplied from the mains)
- The battery symbol steadily illuminated or flashing (if batteries are flat or are being recharged)
- The timer symbol
- The two "flash" symbols to indicate a dangerous voltage
- The message "**MEASURING...**"

While measuring, it is also possible to display the leakage current, the capacitance the number N of the cycle the instrument is performing, which cyclically show when pressing the arrow keys.

9. If you want to stop the test in advance before the set number N of cycles is reached, press the **START/STOP** key.
- 10a. Once measurement is complete and any capacitance has been discharged, the instrument shows:
- The value of the measured insulation resistance
 - The value of the actually generated voltage V1
 - The value of the time relevant to parameter T1
 - If the measured resistance value is between the (MIN - MAX) limits previously set, the instrument shows OK and gives a double acoustic signal (see § 4.10.1, § 4.10.2, § 4.10.3)



OR

10b. Once measurement is complete and any capacitance has been discharged, the instrument shows:

- The value of the measured insulation resistance
- The value of the actually generated voltage V1
- The value of the time relevant to parameter T1
- If the measured resistance value is not between the (MIN - MAX) limits previously set, the instrument shows NOT OK, the alarm bell and gives a long acoustic signal (see § (§ 4.10.1, § 4.10.2, § 4.10.3)

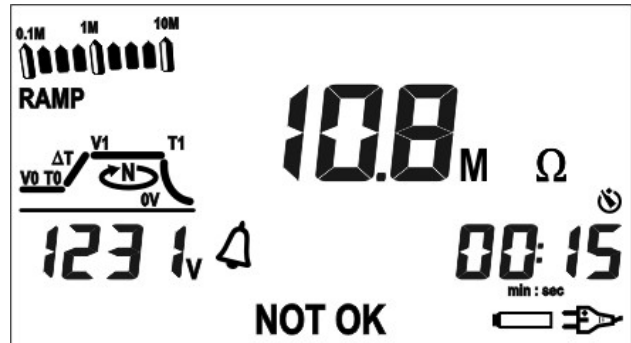

11. Once measurement is complete, it is also possible to display the leakage current, the capacitance the number N of cycles in which the set ramp was repeated, which cyclically show when pressing the arrow keys

CAUTION



- If the measured resistance value $< 5,0M\Omega$, the screen displaying the capacitance shows three hyphens “---”, to indicate that it was impossible to measure the capacitance, and the CAUTION triangle
- If, when scrolling the results obtained, the capacitance value is $> 1nF$, it is recommended to repeat the measurement by activating the SMOOTH function (see § 4.11)

12. Measures can be saved by pressing the **SAVE** key twice (see § 5.1)

4.10.1 Configuration of the test parameters for RAMP#1 mode

- a. By cyclically pressing the **SET/DISPLAY MEM** key, it is possible to select the following parameters:
 - Minimum value of the insulation (MIN) in a range between 0,01M Ω - MAX
 - Maximum value of the insulation (MAX) in a range between (MIN) - 10T Ω
 - Value of time interval ΔT , in which the test voltage passes from 0V to the set value V1
 - Value of the test voltage V1 in a range between 100V - 5000V (can be set in steps of 25V up to 1000V and in steps of 50V from 1000V to 5000V)
 - Value of time T1 in which the test voltage V1 is applied, in a range between (00min:05sec) - (99min:59 sec)
 - Number N of cycles in which the ramp is repeated, in a range between 1 - 255 (N=1 indicates 1 only test without repetitions)
- b. Press the arrow keys to change the value of the parameters (a long pressing of the keys allows a rapid change of the values)
- c. Press the **MODE/CLEAR SMOOTH** key to remove the limit values set for the parameters. The display shows the message "no" to indicate that there is no limit set. When setting the value of the time interval ΔT , of the test voltage V1, of time T1 and of the number N of cycles, by pressing the **MODE/CLEAR SMOOTH** key, the default values are set (respectively 30sec, 1000V, 1min, 1 cycle)
- d. After setting, press the **SAVE** key to save the changes made or press the **ESC/RECALL MEM** key to exit without saving and return to the previous screen

4.10.2 Configuration of the test parameters for RAMP#2 mode

- a. By cyclically pressing the **SET/DISPLAY MEM** key, it is possible to select the following parameters:
 - Minimum value of the insulation (MIN) in a range between 0.01M Ω - MAX
 - maximum value of the insulation (MAX) in a range between (MIN) - 10T Ω
 - Value of the starting voltage V0 in a range between 100V - 1000V (can be set in steps of 25V)
 - Value of time T0 in which the test voltage V0 is applied, in a range between (00min:05sec) - (99min:59 sec)
 - Value of time interval ΔT in which the test voltage passes from the set value V0 to the set value V1, in a range between (00min:05sec) - (99min:59 sec);
 - Value of the test voltage V1 in a range between 1000V - 5000V (can be set in steps of 50V)
 - Number N of cycles in which the ramp is repeated, in a range between 1 - 255 (N=1 indicates 1 only test without repetitions).
- b. Press the arrow keys to change the value of the parameters (a long pressing of the keys allows a rapid change of the values).
- c. Press the **MODE/CLEAR SMOOTH** key to remove the limit values set for the parameters. The display shows the message "no" to indicate that there is no limit set. When setting the value of voltage V0, of time T0, of time interval ΔT , of voltage V1 and of the number N of cycles, by pressing the **MODE/CLEAR SMOOTH** key, the default values are set (respectively 100V, 15sec, 30sec, 1000V, 1 cycle).
- d. After setting, press the **SAVE** key to save the changes made or press the **ESC/RECALL MEM** key to exit without saving and return to the previous screen.

4.10.3 Configuration of the test parameters for RAMP#3 mode

- a. By cyclically pressing the **SET/DISPLAY MEM** key, it is possible to select the following parameters:
 - Minimum value of the insulation (MIN) in a range between 0.01M Ω - MAX
 - Maximum value of the insulation (MAX) in a range between (MIN) - 10T Ω
 - Value of the starting voltage V0 in a range between 100V - 1000V (can be set in steps of 25V);
 - Value of time T0 in which the test voltage V0 is applied, in a range between (00min:05sec) - (99min:59 sec);
 - Value of time interval ΔT in which the test voltage passes from the set value V0 to the set value V1, in a range between (00min:05sec) - (99min:59 sec);
 - Value of the test voltage V1 in a range between 1000V - 5000V (can be set in steps of 50V);
 - Value of time T1 in which the test voltage V1 is applied, in a range between (00min:05sec) - (99min:59 sec);
 - Number N of cycles in which the ramp is repeated, in a range between 1 - 255 (N=1 indicates 1 only test without repetitions).
- b. Press the arrow keys to change the value of the parameters (a long pressing of the keys allows a rapid change of the values).
- c. Press the **MODE/CLEAR SMOOTH** key to remove the limit values set for the parameters. The display shows the message "no" to indicate that there is no limit set. When setting the value of voltage V0, of time T0, of time interval ΔT , of voltage V1, of time T1 and of the number N of cycles, by pressing the **MODE/CLEAR SMOOTH** key, the default values are set (respectively 100V, 15sec, 30sec, 1000V, 1min, 1 cycle).
- d. After setting, press the **SAVE** key to save the changes made or press the **ESC/RECALL MEM** key to exit without saving and return to the previous screen.

4.11 ENABLE/DISABLE OF SMOOTH FUNCTION

1.  With the instrument in normal mode (no SET of parameters), press and hold the MODE/CLEAR SMOOTH key for approximately 3 seconds. On the display, the word SMOOTH appears (or disappears, if already displayed). This feature is suggested with very high capacitance loads presence in order to improve the readings at display.

4.12 ANOMALOUS SITUATIONS

1. If, upon pressing the **START/STOP** key, the voltage at input leads -Rx, +Rx is > allowable limit voltage, the instrument gives a long acoustic signal and displays the screen reported here to the side for 3 seconds. Afterwards, the instrument returns to the initial screen.

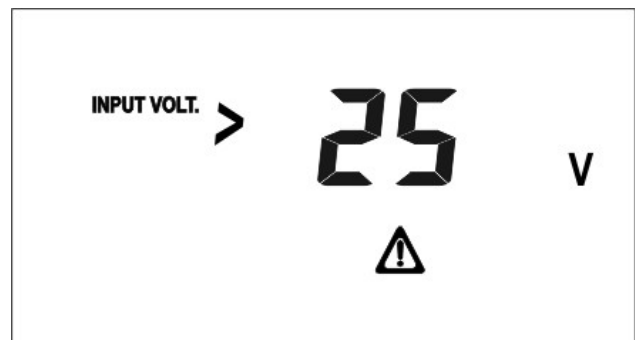

2. If, upon pressing the **START/STOP** key (with nominal test voltage set to $\leq 1000V$ and load resistance $\geq 5M\Omega$), the capacitance at input leads -Rx, +Rx is $>$ allowable limit capacitance, the instrument gives a long acoustic signal and displays the screen reported here to the side for 3 seconds. Afterwards, the instrument returns to the initial screen.



3. If, upon pressing the **START/STOP** key (with $1000V <$ nominal test voltage set $\leq 2500V$ and load resistance $\geq 5M\Omega$), the capacitance at input leads -Rx, +Rx is $>$ allowable limit capacitance, the instrument gives a long acoustic signal and displays the screen reported here to the side for 3 seconds. Afterwards, the instrument returns to the initial screen.



4. If, upon pressing the **START/STOP** key (with $2500V <$ nominal test voltage set $\leq 5000V$ and load resistance $\geq 5M\Omega$), the capacitance at input leads -Rx, +Rx is $>$ allowable limit capacitance, the instrument gives a long acoustic signal and displays the screen reported here to the side for 3 seconds. Afterwards, the instrument returns to the initial screen.



5. If, upon pressing the **START/STOP** key or if, while measuring, an insufficient level of the supply battery voltage is detected, so that the success of the test is prejudiced, measurement does not start or is stopped. The instrument gives a long acoustic signal and displays the screen reported here to the side for 3 seconds. Afterwards, the instrument returns to the initial screen.



6. If there are no data saved in the instrument's memory, upon pressing the **ESC/RECALL MEM** key, the instrument gives a long acoustic signal and displays the screen reported here to the side for 3 seconds. Afterwards, the instrument returns to the initial screen.



7. If there are no memory cells available to save the measurement results, upon pressing the **SAVE** key, the instrument gives a long acoustic signal and displays the screen reported here to the side for 3 seconds. Afterwards, the instrument returns to the initial screen.



8. The above-mentioned anomalous situations cannot be saved.

5 MANAGEMENT OF MEMORY DATA

5.1 SAVE MEASUREMENTS

- After performing a measurement, press the **SAVE** key. The display shows a screen similar to that reported here to the side, which contains:
 - The number of the memory location in which the measure will be saved
 - The last set value for parameter P



- Should you desire to change the value of parameter P, press the arrow keys to set the desired value (from 1 to 255). This value helps remembering the location in which the measurement considered has been performed.
- Confirm measure saving by pressing the **SAVE** key or press the **ESC/RECALL MEM** key to go back to the previous screen without saving data in the memory

5.2 DELETE MEASUREMENTS

- Press the **ESC/RECALL MEM** key. The display shows a screen similar to that reported here to the side, which contains:
 - The number of the last memory location used
 - The value of parameter P



- Press the **FUNC/ERASE MEM** key; the instrument displays a screen similar to that reported here to the side, which shows the word "LAST", to indicate that the last measure saved will be deleted



- Press the arrow keys; the instrument displays a screen similar to that reported here to the side, which shows the word "ALL", to indicate that all the measures saved will be deleted.



- Confirm deletion by pressing the **FUNC/ERASE MEM** key or press the **ESC/RECALL MEM** key to go back to the previous screen without deleting data

5.3 RECALL MEASUREMENTS

1. Press the **ESC/RECALL MEM** key. The display shows a screen similar to that reported here to the side, which contains:
 - The number of the last memory location used
 - The value of parameter P

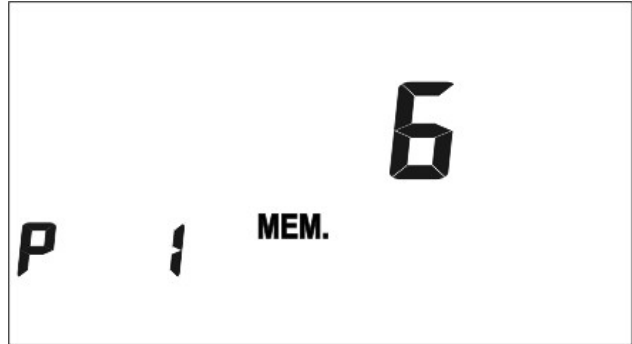

2. Press the arrow keys to select the memory location whose content is to be displayed.
3. Press the **SET/DISPLAY MEM** key to display the measure contained in the selected memory location, the display shows a screen similar to that reported here to the side.

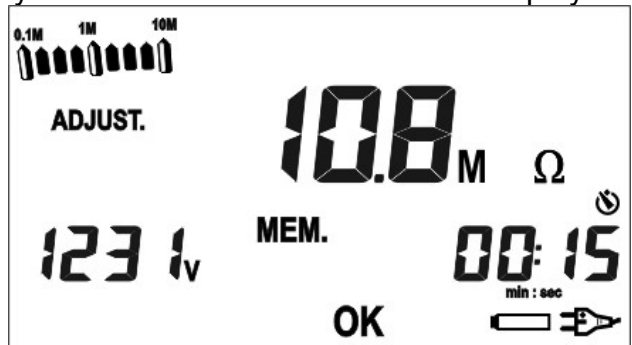

4. By pressing the arrow keys it is also possible to cyclically display (according to the mode in which the saved measurement was performed) the leakage current, the DAR (Dielectric Absorption Ratio), the PI (Polarization Index), the capacitance and the number N of cycles.
5. Press the **ESC/RECALL MEM** key to go back to the previous screen and press the **ESC/RECALL MEM** key again to exit memory management.

6 RESET OF INSTRUMENT

1. Turn on the instrument by pressing the relevant key
2. Press and hold the **SET/DISPLAY MEM** key. After approximately 10 seconds, the instrument is reset and turns off

7 CONNECTION OF THE INSTRUMENT TO PC

The connection between the PC and the instrument is obtained by means of a serial port and the C232NG1 cable, supplied with the software pack. Before connection, it is necessary to select the COM port used for transmission by the PC and the correct baud rate (9600). To set these parameters, launch the management software and consult the program's help on line.

CAUTION



The selected port must NOT be used by other devices or applications (e.g. mouse, modem, etc...).

The procedure for transferring saved data to a PC can be schematized as follows:

1. Turn on the instrument and wait for the initial screen to disappear
2. Connect the RS-232 cable to the instrument and to a COM port of the PC
3. Launch the data management program on the PC
4. Follow the instructions of the software's help on line

8 MAINTENANCE

8.1 GENERAL INFORMATION

1. The instrument You purchased is a precision instrument. During use and storage, carefully observe the recommendations listed in this manual in order to prevent possible damage or dangers during use
2. Do not use the instrument in environments with high humidity levels or at high temperatures. Do not directly expose to sunlight
3. Always turn off the instrument after use. Never remove the front panel of the instrument. The instrument don't need any particular maintenance.



8.2 RECHARGING INTERNAL BATTERY

When the LCD displays the symbol "", it is necessary to recharge the battery.



CAUTION

Only expert and trained technicians should perform maintenance operations. Before carrying out this operations, make sure you have disconnected all cables from the input terminals

1. Fit the power cord in the Europlug socket (see Fig. 1 – part 2) with no measurements performed by the instrument
2. The "" symbol is shown at display to indicate the running of recharging process
3. Leave the instrument until the "" symbol is shown at display. With the battery on charge is possible to perform measurements

8.3 CLEANING THE INSTRUMENT

To clean the instrument, use a soft dry cloth. Never use humid cloths, solvents, water, etc.

8.4 END OF LIFE



CAUTION: the reported symbol indicates that the appliance and its accessories must be disposed of separately and treated correctly.

9 TECHNICAL SPECIFICATIONS

Uncertainty is indicated as [% rdg + (dgt number * resolution)] at $23 \pm 5^\circ\text{C}$, < 80%HR

Vdc Voltage

| Range | Resolution | Uncertainty | Protection against overloads |
|-----------|------------|------------------------------------|------------------------------|
| 10 ÷ 600V | 1V | $\pm(2.0\%\text{rdg}+2\text{dgt})$ | CAT IV 600V to earth |

Vac TRMS Voltage

| Range | Resolution | Uncertainty | Protection against overloads |
|-----------|------------|------------------------------------|------------------------------|
| 10 ÷ 600V | 1V | $\pm(2.0\%\text{rdg}+2\text{dgt})$ | CAT IV 600V to earth |

Insulation resistance – Intrinsic uncertainty (at the reference conditions)

| Range | Test voltage | Resolution | Uncertainty (*) |
|--------------------------------------|---------------------|----------------------|--|
| 0.01M Ω ÷ 0.19M Ω (**) | $\geq 100\text{V}$ | $\leq 1\%\text{rdg}$ | $\pm(5\%\text{rdg}+7\text{dgt})$ |
| 0.20M Ω ÷ 199G Ω | $\geq 100\text{V}$ | | $\pm(5\%\text{rdg}+3\text{dgt})$ if $R_{mis} \leq \frac{\text{Test Voltage}}{5nA}$ |
| 0.20M Ω ÷ 499G Ω | $\geq 250\text{V}$ | | |
| 0.20M Ω ÷ 999G Ω | $\geq 500\text{V}$ | | $\pm(20\%\text{rdg}+3\text{dgt})$ if $R_{mis} > \frac{\text{Test Voltage}}{5nA}$ |
| 0.20M Ω ÷ 1.99T Ω | $\geq 1000\text{V}$ | | |
| 0.20M Ω ÷ 4.99T Ω | $\geq 2500\text{V}$ | | |
| 0.20M Ω ÷ 9.99T Ω | 5000V | | |

(*) Load Capacitive < 1nF

(**) Outside range indicated by IEC/EN61557

Resistance measurement – Operating uncertainty (compliance with conditions of IEC/EN61557-1)

| Range | Test voltage | Resolution | Uncertainty (*) |
|--------------------------------------|---------------------|------------------------|---|
| 0.01M Ω ÷ 0.19M Ω (**) | $\geq 100\text{V}$ | $\leq 1\% \text{ rdg}$ | $\pm(12\%\text{rdg}+7\text{dgt})$ |
| 0.20M Ω ÷ 199G Ω | $\geq 100\text{V}$ | | $\pm(12\%\text{rdg}+3\text{dgt})$ if $R_{mis} \leq \frac{\text{Test Voltage}}{5nA}$ |
| 0.20M Ω ÷ 499G Ω | $\geq 250\text{V}$ | | |
| 0.20M Ω ÷ 999G Ω | $\geq 500\text{V}$ | | $\pm(20\%\text{rdg}+3\text{dgt})$ if $R_{mis} > \frac{\text{Test Voltage}}{5nA}$ |
| 0.20M Ω ÷ 1.99T Ω | $\geq 1000\text{V}$ | | |
| 0.20M Ω ÷ 4.99T Ω | $\geq 2500\text{V}$ | | |
| 0.20M Ω ÷ 9.99T Ω | 5000V | | |

(*) Load Capacitive < 1nF

(**) Outside range indicated by IEC / EN61557

Measurement of generated voltage (*)

| Test mode | Nominal test voltages | Uncertainty |
|------------|-----------------------------------|-----------------|
| FIX | 100V, 250V, 500V, 1kV, 2.5kV, 5kV | -0%, +10% + 15V |
| ADJUSTABLE | 100 ÷ 1000V, step 25V | |
| | 1000 ÷ 5000V, step 50V | |
| RAMP | 100 ÷ 1000V, step 25V | |
| | 1000 ÷ 5000V, step 50V | |

(*) Test voltage compliance with IEC / EN 61557-2

Test current

| Test voltage | Test current |
|--------------|--|
| 100 ÷ 5000V | 1mA \leq Test current \leq 3mA (*) |

(*) Automatically controlled test current.

Test time

| Setting range | Resolution |
|----------------|------------|
| 5s – 99min 59s | 1s |

Capacitance measurement

| Range | Resolution | Load resistance | Test voltage (Vn) | Uncertainty |
|-----------------|------------|-----------------|-------------------|----------------|
| 1nF ÷ 999nF | 1nF | ≥ 5MΩ | Vn ≤ 5000V | ±(10%rdg+5dgt) |
| 1.00μF ÷ 5.00μF | 0.01μF | | | |
| 1nF ÷ 999nF | 1nF | | Vn ≤ 2500V | |
| 1.00μF ÷ 9.99μF | 0.01μF | | | |
| 10.0μF ÷ 19.9μF | 0.1μF | | Vn ≤ 1000V | |
| 1nF ÷ 999nF | 1nF | | | |
| 1.00μF ÷ 9.99μF | 0.01μF | | | |
| 10.0μF ÷ 49.9μF | 0.1μF | | | |

Charge time of capacitance (0V → 5000V): < 3s x 1μF

Discharge time of capacitance (5000V → 25V): < 5s x 1μF

Leakage current

| Range | Resolution | Uncertainty |
|-----------------|------------|---|
| 0.1nA ÷ 99.9nA | 0.1nA | ±(7%rdg+3dgt) if $R_{mis} \leq \frac{\text{Test Voltage}}{5nA}$ |
| 100nA ÷ 999nA | 1nA | |
| 1.00μA ÷ 9.99μA | 0.01μA | |
| 10.0μA ÷ 9.99μA | 0.1μA | ±(22%rdg+3dgt) if $R_{mis} > \frac{\text{Test Voltage}}{5nA}$ |
| 100μA ÷ 999μA | 1μA | |
| 1.00mA ÷ 2.5mA | 0.01mA | |

PI – DAR

| Range | Resolution | Uncertainty (*) |
|-------------|------------|---|
| 0.01 ÷ 9.99 | 0.01 | ±(5%rdg+3dgt) if $R_{mis} \leq \frac{\text{Test Voltage}}{5nA}$ |
| | | ±(20%rdg+3dgt) if $R_{mis} > \frac{\text{Test Voltage}}{5nA}$ |

(*) Load capacitance < 1nF

9.1 REFERENCE GUIDELINES

| | |
|-----------------------------|---|
| Instrument safety: | IEC/EN61010-1, IEC/EN61557-1, IEC/EN61557-2 |
| Measuring accessory safety: | IEC/EN 61010-031:2002 + A1:2008 |
| Technical documentation: | IEC/EN61187 |
| Insulation: | double insulation |
| Protection: | IP40 (open case), IP53 (closed case) according to IEC / EN60529 |
| Polluting level: | 2 |
| Measurement category: | CAT IV 600V (to earth), max 600V between inputs |
| Maximum height of use: | 2000m (6561ft) |

9.2 GENERAL CHARACTERISTICS
Mechanical characteristics

| | |
|-------------------------|-----------------------------------|
| Dimensions (L x W x H): | 360 x 310 x 195mm (14 x 12 x 8in) |
| Weight: | 3.5kg (7.8lb) |

Power supply

| | |
|-------------------------|--|
| External power supply: | 220-240VAC, 50-60Hz, 20VA (HT7051) 110-120VAC, 50-60Hz, 20VA (HT7051N) |
| Battery type: | internal rechargeable NiMH battery |
| Fuse: | T 200mA H 250V, Ir: 1,5kA |
| Low battery indication: | symbol "  " at display. |

Battery life: >1000 Test @ 5kV on 5M Ω (Test time: 5sec, delay between 2 test: 25sec) according to IEC/EN61557-2. (§ 6.7)

Auto Power OFF: after 5 min of idleness

Display

Characteristics: LCD with backlight with 3 contemporary readings:
Group 1 (main): insulation resistance, leakage current, PI, DAR, capacitance
Group 2: test voltage (nominal and generated)
Group 3: test time

Memory

Characteristics: 700 memory locations

Connection to PC

Serial interface: RS-232 optoinsulated

9.3 ENVIRONMENT

9.4.1. Environmental conditions for use

Reference temperature: $23 \pm 5^{\circ}\text{C}$ ($73 \pm 41^{\circ}\text{F}$)
Operating temperature: $0 \div 40^{\circ}\text{C}$ ($32 \div 104^{\circ}\text{F}$)
Allowable relative humidity: <80%HR
Storage temperature: $-10 \div 60^{\circ}\text{C}$ ($14 \div 140^{\circ}\text{F}$)
Storage humidity: <80%HR

| |
|---|
| <p>This instrument complies with the requirements of European Directive on low voltage 2006/95/EC (LVD) and of Directive EMC 2004/108/EC</p> |
|---|

9.4 ACCESSORIES

See enclosed packing list.

10 SERVICE

10.1 WARRANTY CONDITIONS

This instrument is warranted against any material or manufacturing defect, in compliance with the general sales conditions. During the warranty period, defective parts may be replaced. However, the manufacturer reserves the right to repair or replace the product.

Should the instrument be returned to the After-sales Service or to a Dealer, transport will be at the Customer's charge. However, shipment will be agreed in advance.

A report will always be enclosed to a shipment, stating the reasons for the product's return. Only use original packaging for shipment; any damage due to the use of non-original packaging material will be charged to the Customer.

The manufacturer declines any responsibility for injury to people or damage to property.

The warranty shall not apply in the following cases:

- Repair and/or replacement of accessories and battery (not covered by warranty).
- Repairs that may become necessary as a consequence of an incorrect use of the instrument or due to its use together with non-compatible appliances.
- Repairs that may become necessary as a consequence of improper packaging.
- Repairs which may become necessary as a consequence of interventions performed by unauthorized personnel.
- Modifications to the instrument performed without the manufacturer's explicit authorization.
- Use not provided for in the instrument's specifications or in the instruction manual.

The content of this manual cannot be reproduced in any form without the manufacturer's authorization.

Our products are patented and our trademarks are registered. The manufacturer reserves the right to make changes in the specifications and prices if this is due to improvements in technology.

10.2 SERVICE

If the instrument does not operate properly, before contacting the After-sales Service, please check the conditions of battery and cables and replace them, if necessary.

Should the instrument still operate improperly, check that the product is operated according to the instructions given in this manual.

Should the instrument be returned to the After-sales Service or to a Dealer, transport will be at the Customer's charge. However, shipment will be agreed in advance.

A report will always be enclosed to a shipment, stating the reasons for the product's return. Only use original packaging for shipment; any damage due to the use of non-original packaging material will be charged to the Customer.

11 THEORETICAL APPENDIX

11.1 POLARIZATION INDEX (PI)

PI is the ratio of Insulation Resistance values measured after 1 minute and after 10 minutes. The DC test voltage is present during the whole period of the measurement (an Insulation Resistance measurement is also running). On completion of the test the PI ratio is displayed

$$PI = \frac{Rins (10 \text{ min})}{Rins (1 \text{ min})}$$

General applicable values:

| PI value | Insulation conditions |
|------------------|-----------------------|
| from 1.0 to 1.25 | Not acceptable |
| from 1.4 to 1.6 | Good |
| >1.6 | Excellent |

11.2 DIELECTRIC ABSORPTION RATIO (DAR)

DAR is ratio of insulation resistance values measured after 30s and after 1 minute. The DC test voltage is present during the whole period of the test (also an Insulation Resistance measurement is continually running). At the end, the DAR ratio is displayed:

$$DAR = \frac{Rins (1 \text{ min})}{Rins (30 \text{ s})}$$

General applicable values:

| DAR value | Insulation conditions |
|-----------------|-----------------------|
| < 1.0 | Dangerous |
| from 1.0 to 2.0 | Not acceptable |
| from 2.0 to 4.0 | Good |
| > 4.0 | Excellent |